

Mini Assembly Instructions

PARTS LIST

A. Rails Brackets

2x 

D. Rails Standard

5x 

H. Rails Hooks (198cm)

2x 

B. End Frame

2x 

K. Screw

4x 

C. Strap

2x 

E. Bracket

4x 

I. Bolt

8x 

F. Nut

8x 

J. Washer

12x 

1

Attach the **A. Rail Brackets** to the **E. Brackets** using **I. Bolt**, **F. Nut** & **J. Washer** on both ends

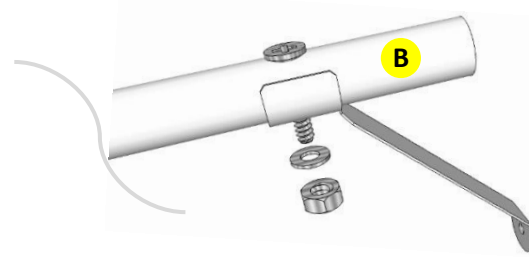
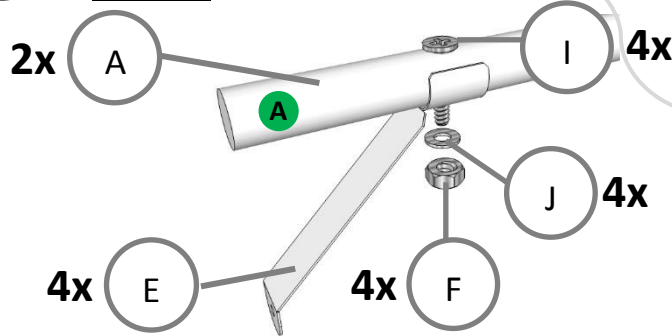

2

Align the two **A. Rail Brackets** so the different ends are opposite each other. Slide the **C. Strap** on to the ends of the **A. Rail Brackets**

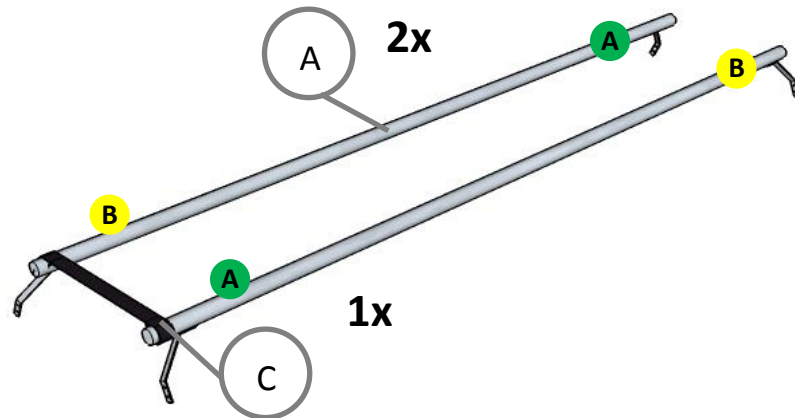

3

On one end of the **B. End Frame**, Attach the **A. Rail Brackets**

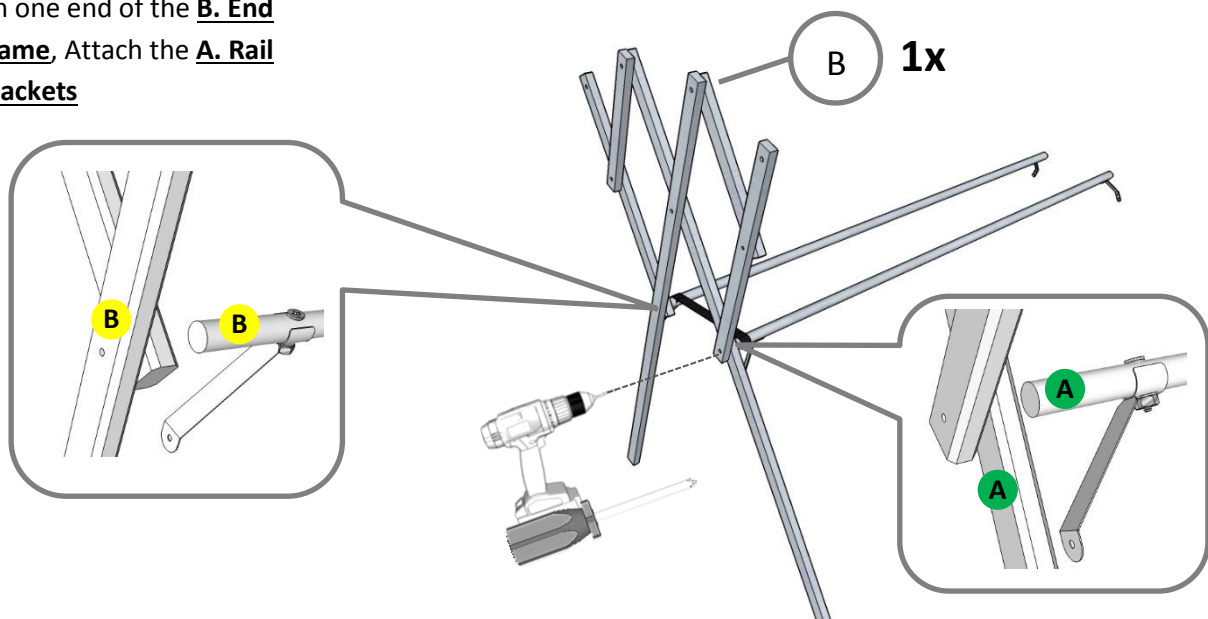

4

Slide the **C. Strap** on to the ends of the **A. Rail Brackets**

On the other end of the **A. Rail Brackets** attach the **B. End Frame**

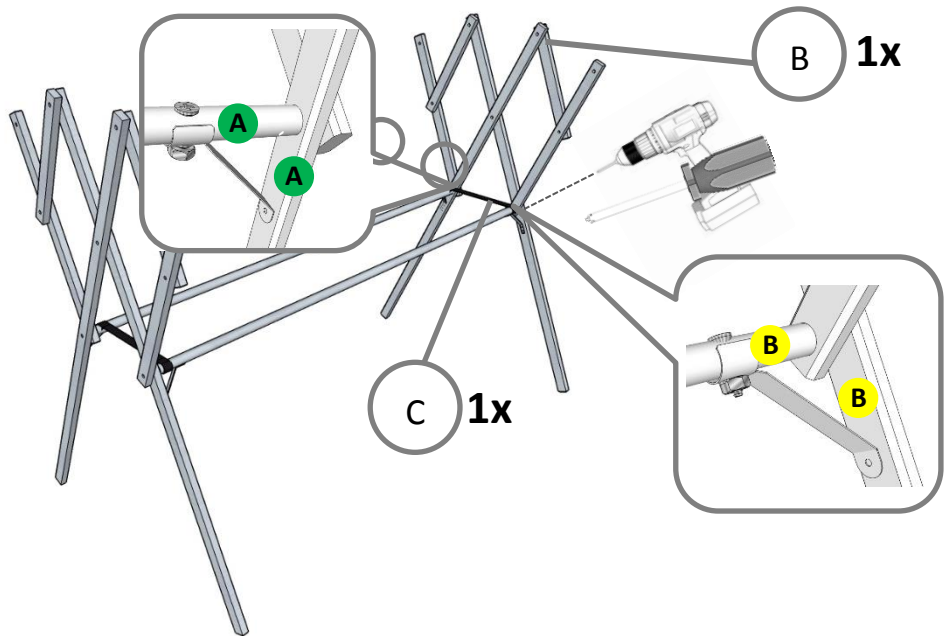

5

On one end of the **B. End Frame**, Attach the **D. Rail Standard**. Attach the other end. Repeat for remaining 4x **D. Rail Standard**.

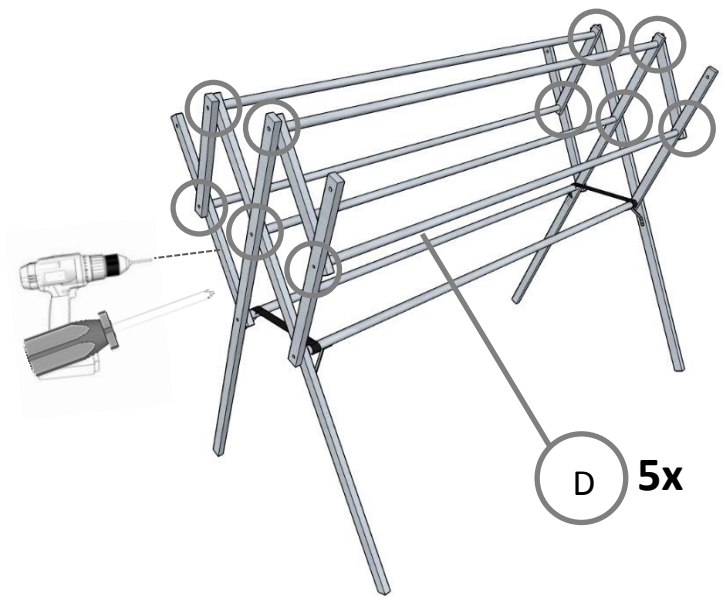

6

On one end of the **B. End Frame**, Attach the **H. Rail Hooks**. Attach the other end.

Repeat for remaining 1x **H. Rail Hooks**.

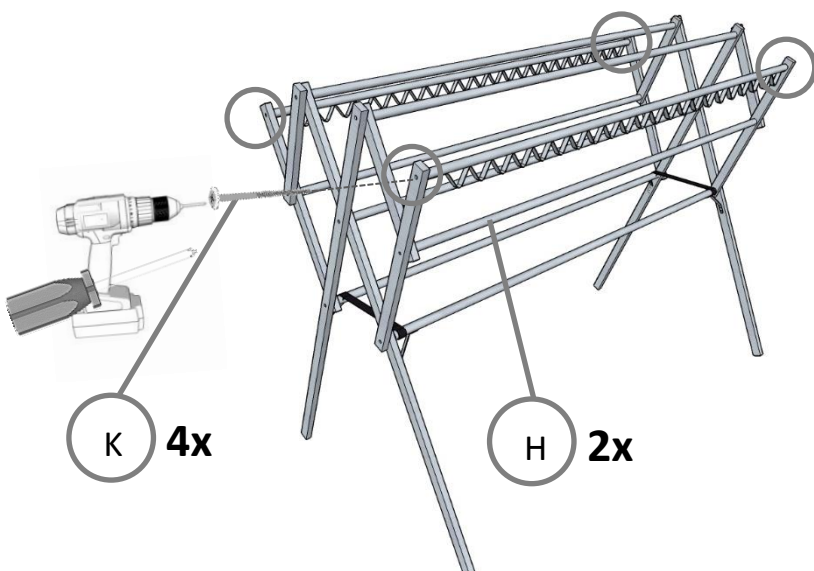

7

Attach the **E. Bracket** to the **B. End Frame** using **I. Bolt**, **F. Nut** & **J. Washer**.

Repeat for remaining 3x **E. Bracket**

